

# Crawler Crane Series SCC800C

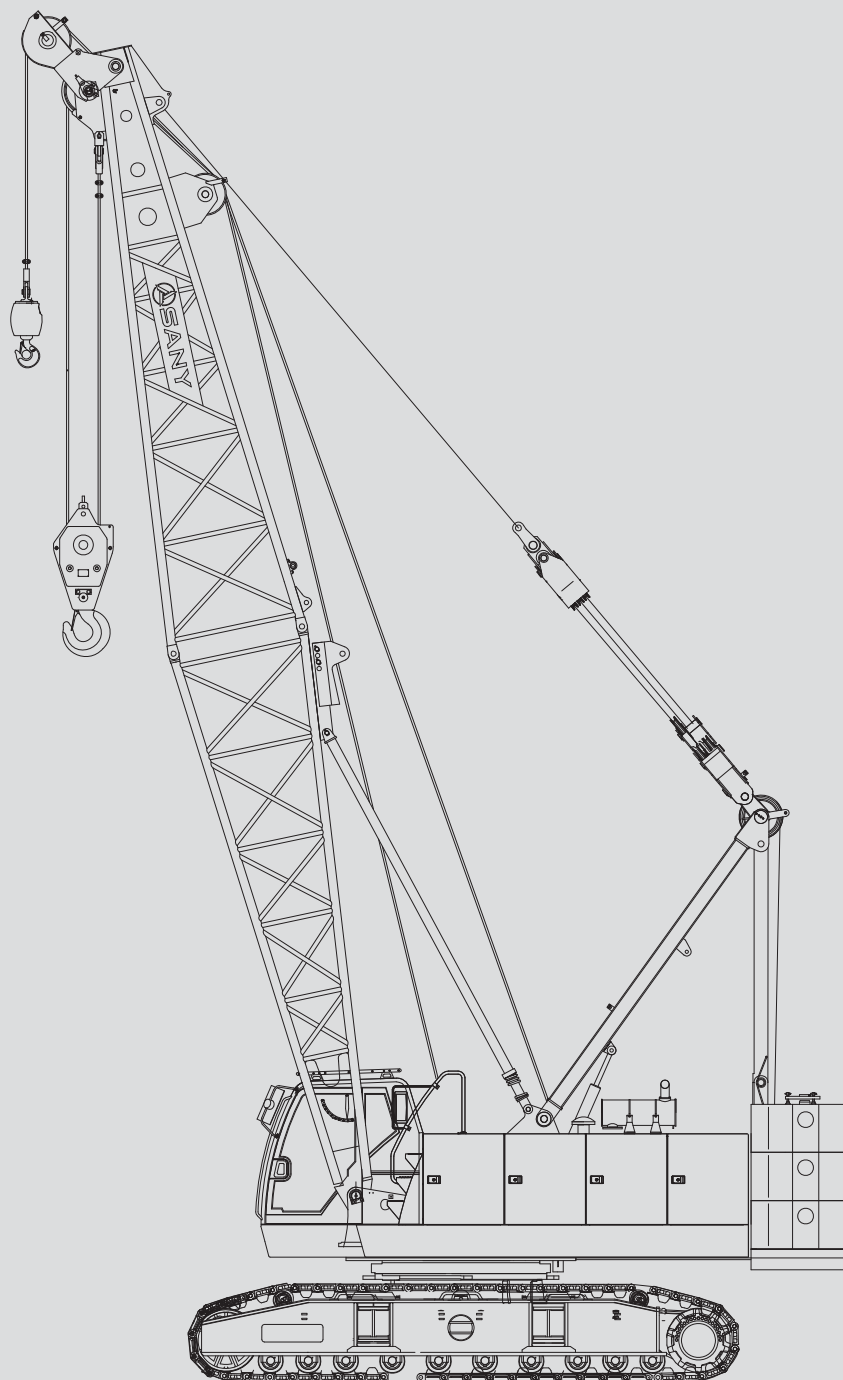

# A

## **SCC800c Crawler Crane Series 03**

---

Basic Dimensions of the Whole Machine	04
Main Technical Features	05
Main Performance Data	06
Transport Dimensions	07

# B

## **Specification 11**

---

Specifications	12
Lowerworks	14
Operation Device	15
Safety Devices	16

# C

## **Operating Condition Combination 19**

---

Operating Condition Combination	20
H Operating Condition of Boom	
Boom Combination of H Operating Condition	21
Operating Range Diagram of H Operating Condition	
Operating Condition	22
Boom Load Charts of H Operating Condition	23
FJ Operating Condition of Fixed Jib	
Arm Support Combination of FJ Operating Condition	
Operating Condition	26
Operating Range Diagram of FJ Operating Condition	
Condition	27
Jib Load Charts of FJ Operating Condition	28

SCC800C

# A

---

04 Basic Dimensions of the Whole Machine

---

05 Main Technical Features

---

06 Main Performance Data

---

07 Transport Dimensions

---

## Basic Dimensions of the Whole Machine

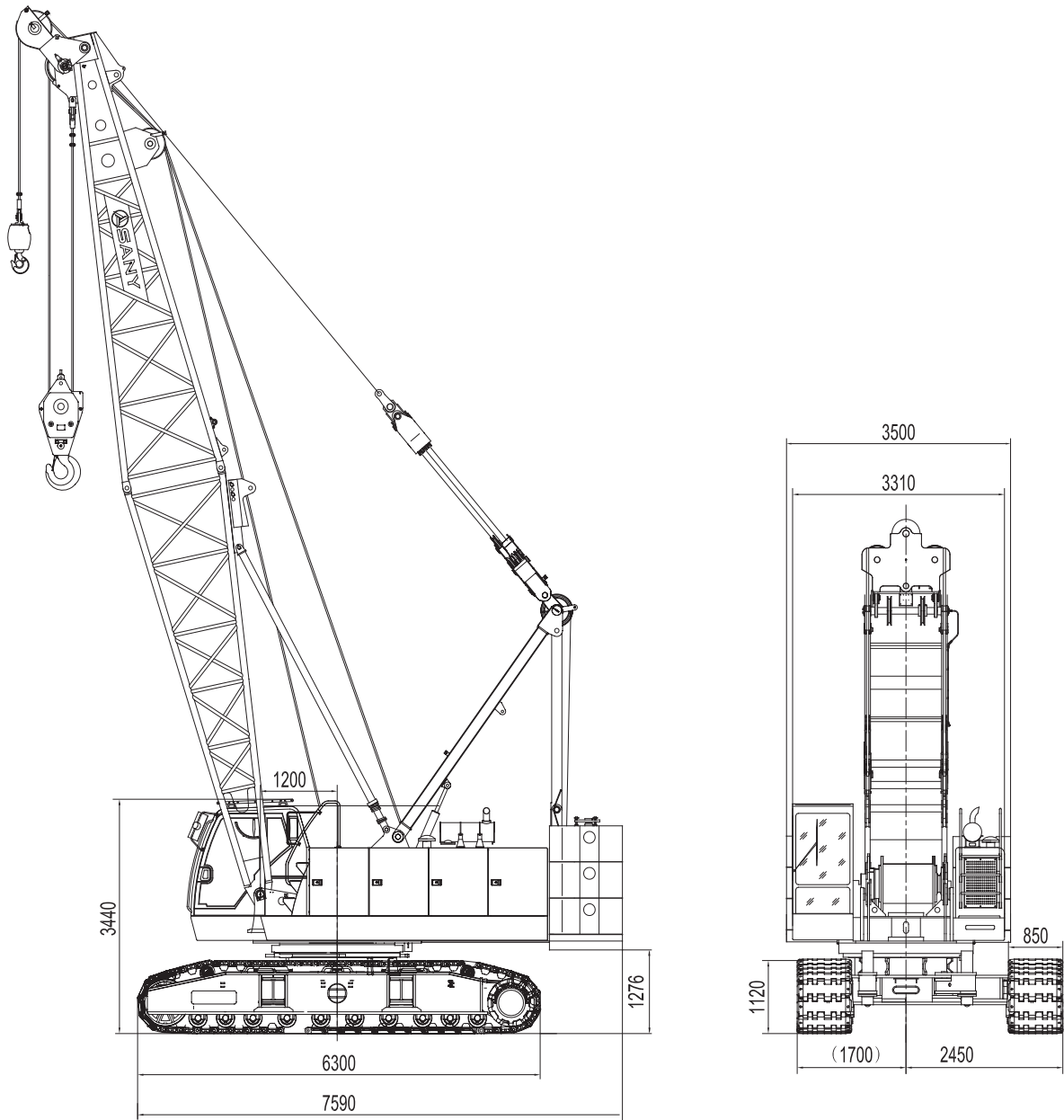

**A**

## ■ Main Technical Features

---

**1. Safe control system:** The two operating modes of working and installation are convenient and reliable; the crane is equipped with the functions of real-time display of levelness, off-line stop action, emergency electric control, lightning protection, automatic traveling direction adjustment, CCTV monitoring, etc., and the safety and monitoring systems are complete;

**2. Outstanding operating performance:** Load sensing, limit load adjustment and electro-hydraulic proportion dead slow control offer the perfect inching performance of actions, and more stable operation;

**3. Reliable function assurance:** The key components are all of world-renowned brands; the designed safety margin of structures and members are sufficient; the control system can operate stably under the harsh environments like extreme cold, high temperature, plateau or sand wind;

**4. Convenient maintenance technology:** the access time of a position requiring adjustment is no more than 10min/person, that of a position requiring daily care is no more than 30min/person, and the maximum maintenance access time is no more than 2h/person; GPS remote monitoring system is equipped to facilitate maintenance and management

of equipment; standard light-duty non-metal anti-slipping pedals are equipped on all arm supports to make installation easier;

**5. Powerful lifting capacity and operation efficiency:** The rated single-rope tension may reach 9.2t, and max. single-rope tension of the main hoist may reach 16t, with loading capacity, hoist and luffing speed improved further;

**6. Flexible configuration combination:** Free-dropping function is optional, or the main and auxiliary winches may have free-dropping function simultaneously; caterpillar crawler of excavator may be optionally used for crawler traveling;

**7. Large-chassis design:** The chassis designed with wide gauge ensures excellent machine and operation stability within 360° slewing range;

**8. Optimized transportation scheme:** With the function of crawler extension, the max. transportation width of the whole machine is 3.4m;

**9. Reliable transmission system:** The hydraulic technology of world-renowned brand ensures high system stability and reliability;

**10. Many optional configurations:** additional functions include free dropping, excavator type crawler, fuel pre-heating, and high pressure alarm, etc.

## ■ Main Performance Data

Main performance data of SCC800C crawler crane			
Performance index		Unit	Data
Boom operating condition	Max. rated lifting capacity	t	80
	Length of boom	m	13~58
	Boom luffing angle	°	30~80
	Max. lifting torque	t.m	344
Operating Condition of Fixed Jib	Fully extended boom + fully extended jib	m	49+18
	Included angle between boom and jib	°	15,30
Working speed	Rope speed of main and auxiliary winch (third tier)	m/min	0~110
	Rope speed of luffing winch (fifth tier)	m/min	0~73
	Slewing speed	rpm	0~2.25
	Travel Speed	km/h	0~2.0
	Gradeability	%	30
Engine	Output power/rated speed	kW/rpm	183/ 2000
Transportation parameter	Maximum transport weight of single piece (with crawler)	t	50
	Transportation size (length x width x height)	mm	13320×3400×3340
Other parameters	Average ground pressure (basic boom)	MPa	0.076

A

## Transport Dimensions

<b>Basic machine (with crawler)</b>	<b>×1</b>
Length	13.32m
Width	3.4m
Height	3.34m
Weight	50t
<b>Basic machine (with crawler disassembled)</b>	<b>×1</b>
Length	7.65m
Width	3.31m
Height	3.07m
Weight	30t
<b>Crawler assembly</b>	<b>×2</b>
Length	6.3m
Width	1.0m
Height	1.12m
Weight	9.8t
<b>Counterweight tray</b>	<b>×1</b>
Length	3.64m
Width	1.14m
Height	0.68m
Weight	6t
<b>Left counterweight block</b>	<b>×3</b>
Length	1.14m
Width	0.97m
Height	0.67m
Weight	3t
<b>Right counterweight block</b>	<b>×3</b>
Length	1.14m
Width	0.97m
Height	0.67m
Weight	3t

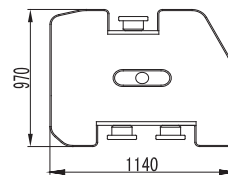
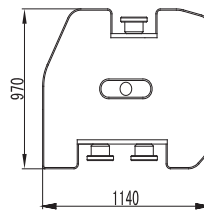
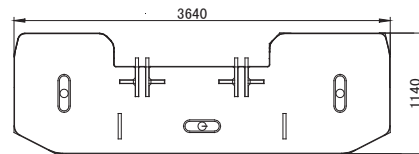
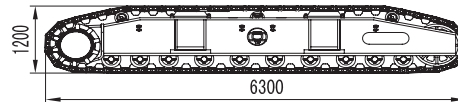
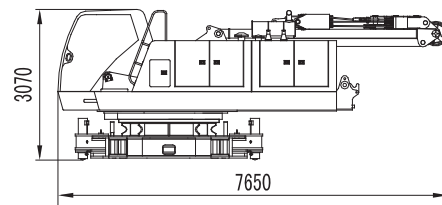
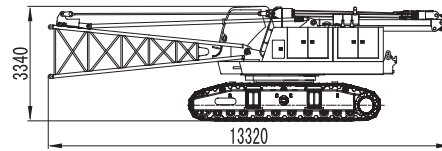

## Transport Dimensions

<b>Central counterweight block</b>	<b>x2</b>
Length	1.64m
Width	0.52m
Height	0.65m
Weight	2.5t
<b>Boom base</b>	<b>x1</b>
Length	6.728m
Width	1.626m
Height	2.035m
Weight	1.6t
<b>Boom tip</b>	<b>x1</b>
Length	6.978m
Width	1.626m
Height	1.785m
Weight	1.65t
<b>3m boom insert</b>	<b>x1</b>
Length	3.136m
Width	1.626m
Height	1.626m
Weight	0.4t
<b>6m boom insert</b>	<b>x1</b>
Length	6.136m
Width	1.626m
Height	1.626m
Weight	0.75t
<b>9m boom insert</b>	<b>x4</b>
Length	9.136m
Width	1.626m
Height	1.626m
Weight	1.05t
<b>Jib tip</b>	<b>x1</b>
Length	4.875m
Width	0.87m
Height	0.77m
Weight	0.35t

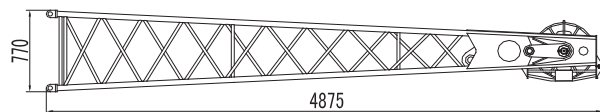
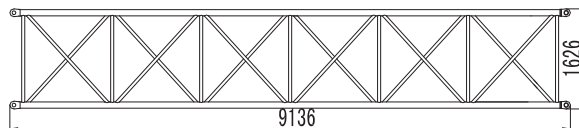
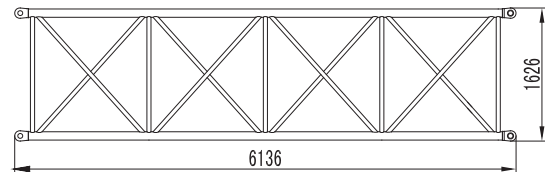
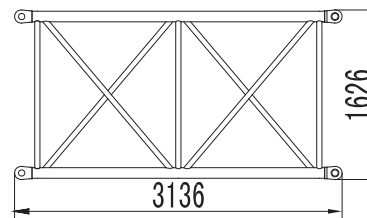
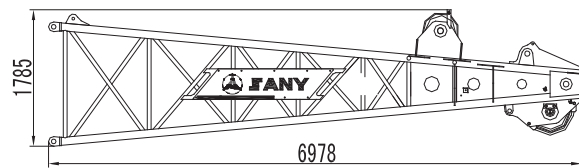
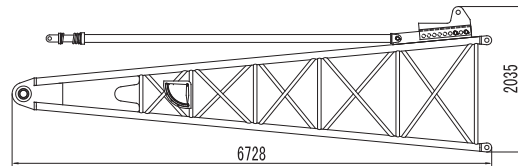
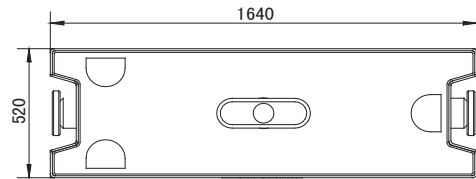



## Transport Dimensions

<b>Jib base</b>	<b>x1</b>
Length	4.69m
Width	0.89m
Height	0.77m
Weight	0.3t
<b>4.5m jib insert</b>	<b>x2</b>
Length	4.57m
Width	0.87m
Height	0.77m
Weight	0.2t
<b>Extension arm</b>	<b>x1</b>
Length	1.15m
Width	0.97m
Height	0.79m
Weight	0.15t
<b>80t hook block</b>	<b>x1</b>
Length	2.1m
Width	0.75m
Height	0.85m
Weight	1.35t
<b>50t hook block</b>	<b>x1</b>
Length	1.99m
Width	0.85m
Height	0.97m
Weight	0.97t
<b>25t hook block</b>	<b>x1</b>
Length	1.79m
Width	0.36m
Height	0.85m
Weight	0.55t

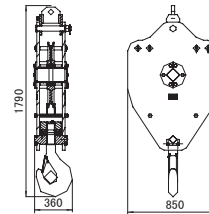
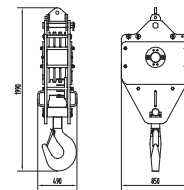
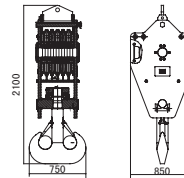
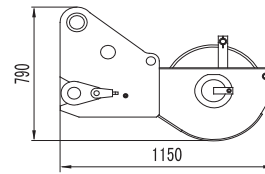
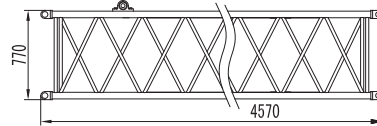
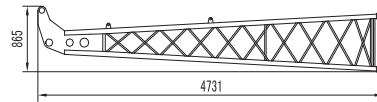

## ■ Transport Dimensions

<b>9t hook block</b>	<b>x1</b>
Length	0.93m
Width	0.36m
Height	0.36m
Weight	0.35t

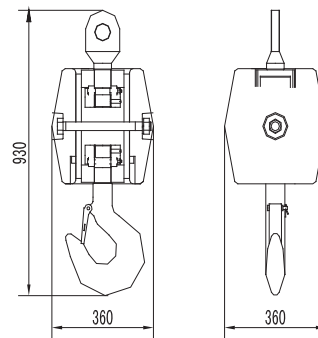

A

**Notes:**

(1) The transport dimensions of the parts are marked on schematic diagrams, but not drawn by scale; the dimensions indicated are the design values excluding package.

(2) The weight is the design value and there may be difference due to the manufacturing error.

# B

---

12 Specifications

---

14 Lowerworks

---

15 Operation Device

---

16 Safety Devices

---



**Specifications**

**Engine**

Imported Cummins QSC8.3;  
 Rated power/speed: 183kW/2000rpm;  
 Emission standard: Tier 3;  
 Air filtering: Two-stage filtering system consisting of air pre-filter and air filter;  
 Optional engine: 6CTAA-250 imported Cummins engine;  
 Rated power/speed: 186KW/2200rpm;  
 Emission standard: Tier 2.

**Electric Control System**

CAN bus is used for data communication among controller, combined instrument, engine, load moment limiter, and remote control terminal.

The combined instrument may indicate working parameters, e.g. rotational speed of the engine, fuel volume, engine oil pressure, servo pressure, wind speed, engine working hours, etc., and working states, e.g. main winch lockup, main luffing lockup, slewing lockup, etc.

**Hydraulic System**

Configuration of hydraulic system: The hydraulic system of a world-renowned brand is used, including main pump, main valve, manipulation handle, and motor reducer, efficient, energy-conserving, stable, and reliable.

With outstanding slewing performance and improved inching property, load sensing and threshold load adjustment, the operation becomes more stable.

The hydraulic oil cooling system under independent control is used.

**Main and Auxiliary Hoisting Mechanisms**

The main and auxiliary winches are driven separately. The reel is directly driven by the winch motor through the reducer. The reel may rotate in two directions through the winch handle, that is, the lifting and dropping of hook.

The motor reducer of a world-renowned brand boasts higher reliability;

Free-dropping function is optional, or the main and auxiliary winches may have free-dropping function simultaneously;

The design of polyline reel ensures smooth multi-layer winding of ropes;

The wire ropes of a world-renowned brand are used,

Main and Auxiliary Hoisting Mechanisms	Rope speed of the outermost working layer	0~110m/min
	Wire rope diameter	φ24mm
	Wire rope length of main/auxiliary hoist	240m/180m
	Rated single rope tension	9.2t

featuring higher reliability and durability.

**Luffing Mechanism**

The reel is directly driven by the luffing motor through the reducer. The reel may rotate in two directions through the winch handle, that is, realize the raising and lowering of lifting arm.

The motor reducer of a world-renowned brand boasts higher reliability;

The design of polyline reel ensures smooth multi-layer winding of ropes;

The wire ropes of a world-renowned brand are used, featuring higher reliability and durability.

Luffing Mechanism	Rope speed of the outermost working layer	0~73m/min
	Wire rope diameter	φ20mm
	Wire rope length of luffing	180m
	Rated single rope tension	6.9t

**Slewing Mechanism**

Outer-engaged slewing drive allows 360° rotation. The motor reducer of a world-renowned brand boasts higher reliability;  
 Slewing lock: Hydraulically controlled locking pin is equipped to ensure the superworks may be locked securely after work or during transportation.  
 Free slipping: If, upon hoisting, the center of arm support and load center are not at the same plane due to incorrect judgment, the function of free slipping may automatically adjust the superworks correctly to prevent the hoisted load from swinging.  
 Slewing ring: Single-row ball Q-series slewing ring.

**Driver’s Cab**

The driver’s cab is equipped with a sliding door in new design, boasting large glass windows; with near and far head lights and rearview mirror, boasting

broader vision; with air conditioner (cool/warm), MP3 player; and seat, control levers, and control buttons all arranged ergonomically, making the operation more comfortable.

Armrest box: The left and right armrest boxes are equipped with control levers, electric switches, and ignition lock, etc. The arm box can also be adjusted with the seat.

Seat: A suspended, multi-direction and multi-position, adjustable seat is equipped with an unloading switch.

Air conditioner: cool and warm air, optimized air channel, and air port.

**Counterweight**

The trays and are cast counterweight blocks are piled in a superimposed way to facilitate combination, assembly and disassembly, and transportation.

Standard counterweight: 27t; composition: tray 6t×1, left counterweight block 3t×3; right counterweight block 3t×3, and central counterweight block 2.5t×1;

Additional counterweight: 2.5t×1.

Under a special condition, additional counterweight block may improve the lifting capacity of medium and long arms.





## Lowerworks

Independent traveling drive is mounted at each crawler frame. The traveling motor achieves straight-line traveling and steering through reducer and driving wheel.

Extension of crawler: The crawler frame is extended and retracted through the extension of cylinder.

Tensity of crawler: Hydraulic jack is used to push the guide pulley, and the adjusting gasket to adjust the tensity of crawler.

Crawler shoe: High-strength, alloy cast steel crawler shoe boasts a longer life.

Caterpillar plane crawler shoe of excavator or crawler shoe with grouser is optional for crawler assembly.

**B**

When there is no restriction on transportation load, the crawler frame may be retracted during transportation, so as to transport the basic machine together with crawler frame and reduce disassembly/assembly time.



## Operation Device

### Boom

In a truss structure, the main chords use high-strength structure steel pipes. All boom sections are connected with pin shafts.

Basic boom: 6.5m tip + +6.5m base;

Insert: 3m×1, 6m×3 and 9m×4;

Boom length: 13m~58m.

### Fixed jib

In a truss structure, the main chords use high-strength structure steel pipes. All boom sections are connected with pin shafts.

Basic boom: 4.5m tip + +4.5m base;

Insert: 4.5m×2;

Jib length: 9m~18m;

Fully extended boom + jib: 49m boom + 18m jib.

### Hook block

80t hook block

50t hook block

25t hook block

9t hook block

Note: The above operation devices are in all configurations, and the specific configuration should be subject to contract for goods.



## Safety Devices

### Switch for Assembling Mode/Operating Mode

Under the assembling mode, the over roll-out limit device, boom limit device and load moment limiter do not function to facilitate installation of crane.

While under the operating mode, all these safety limit devices are functioning.

### Emergency Stop Function

Upon any emergency, the power supply of the whole machine can be cut off and all actions stopped by pushing down the emergency stop button.

Emergency Function

When the system program collapses, an emergent electric plug-in may be used to shift the whole machine to a safe condition for emergency. Then, all safety protection functions are not functioning.

### Load Moment Limiter

As an independent safety operation system controlled by computer, the load moment limiter may automatically detect the load of crane angle of boom, and display the rated loading capacity and actual load, operating radius and angle of lifting arm.

Composition: host, display, angle sensor, and force sensor, etc.

Function: display the data concerning the current situation of crane, including rated load, actual load, operating radius, angle of lifting arm, and height, etc. Detect dynamic data, such as luffing angle overrun and load overrun, and give alarm and restrict action instantly.

### Over Roll-out Limit Device for Main and Auxiliary Hoists

It is composed of limit switch, weight dropper, etc. mounted on the tip and is used to prevent the lifting

hook from being over-lifted. When the lifting hook reaches to a certain height, the limit switch will get actuated, with buzzer on the control panel giving out alarms; meanwhile, the lifting action of the hook will be shut down automatically.

### Over-hoist Limit Device for Main and Auxiliary Hooks

It is composed of the action trigger action and proximity switch inside the reel, to prevent over hoisting of wire rope. When the wire rope is rolled out near the last three circles, the limit switch will get actuated, and with alarms sending out by the buzzer, the system will display the alarm information on the combined instrument and shut off the dropping action of winch automatically.

### Function Locking

If the function locking joystick is not fixed in position, all other functional control levers will not function, so as to prevent misoperation due to knocks of body in getting on and off the crane.

When the operator is not at seat, all manipulations will be out of function, so as to avoid some misoperations effectively.

### Reel Lock Device

The main and auxiliary winches and luffing winch are all equipped with electric-controlled locking devices. Before operating the winch, an operation needs to turn the switch to the release position then act, so as to avoid misoperation of handle and ensure the safety of winch when the crane stops in off-working state.



**Slewing Lock Device**

A hydraulic power pin may lock the crane at four positions, front, back, left and right; the slewing pin and slewing action are electrically interlocked to prevent misoperation.

**A-frame Alarming Device**

In assembly mode, If A-frame is not lifted to the given position, it will be shifted to the working mode; the system will give alarms through the buzzer and display, and all actions are not functioning at the same time.

**Boom Limit Device**

When the angle of lifting arm is over 78°, the buzzer will give alarms and raising operation will be stopped. The protection function is controlled in two stages by load moment limiter and travel switch.

When the angle of lifting arm is below 30°, the system will give alarms through the buzzer and display the alarm information on the combined instrument while shutting off the dropping action automatically. The protection function is automatically controlled by the load moment limiter.

**Boom Back-stop Device**

Composed of nested steel pipe, spring, etc., It prevents the boom from back-tilting by relying on the spring force to buffer the inclining force of boom.

**Boom Angle Indicator**

Pendulum-type angle indicator secured onto the boom base on the side near the driver's cab, Thus facilitating operators to check.

**Hook Clamp**

Every lifting hook is equipped with a clamp plate to prevent wire rope from falling off.

**Monitoring System**

Camera: 2 cameras, respectively for monitoring the auxiliary winch, luffing winch and the rear situation of the crane.

Optional monitoring: zoom monitoring system for monitoring the working state of hooks.

Optional remote monitoring: It may have GPS satellite positioning, GPRS data transmission, enquiry and calculation of equipment use state, monitoring and analysis of operation data, and remote diagnosis of fault.

**Lightning Protection Device**

It includes the grounding device and surge protection device, which can effectively prevent the damages to devices of electrical system and injuries to operators in case of lightning stroke.

**Gradiometer**

The gradiometer may indicate the inclination angle of superworks on the display.

**Tri-color Load Alarming Light**

The load alarming light may show three colors, green, yellow and red, indicating the real-time load synchronically. When the actual load is below 92% of the rated load, the light will turn green; when actual load is above 92% but below 100% of the rated load, the light will turn yellow, and pre-alarming light will twinkle and give out intermittent alarms; when the actual load reaches 100% of the rated load, the light will turn red, and pre-alarming light will twinkle and give out continuous alarms; and when the actual

load reaches 102% of the rated load, the system will automatically cut off the operation of the crane toward danger.

#### **Audio-visual Alarm**

When the engine runs, the light will flash; when the crane travels or slews, it will give audio alarm.

#### **Slewing indicator**

When the crane travels or slews, the slewing indicator will flash.

#### **Illumination**

Night illuminating devices, such as winch illuminator, dipped headlight in front of the driver's cab, front angle-adjustable high beam, illuminator inside the driver's cab, are equipped to improve the visibility during construction.

#### **Rearview Mirror**

Mirrors are respectively set at the right side of the driver's cab and front handrail of cover for the convenience of monitoring the situation at the rear of the machine.

#### **Pharos**

It is mounted on the top of the arm support for guiding from high above.

#### **Seat-leaving Protection**

When the operator is not at seat, all manipulations will be out of function, so as to avoid some misoperations effectively.

#### **Anemometer**

It is installed on the top of arm support to have real-time monitoring over the wind velocity and send data to the driver's cab to display on the monitor there.



---

20 Operating Condition Combination

---

21 H Operating Condition of Boom

Boom Combination of H Operating Condition

---

22 Operating Range Diagram of H Operating Condition

---

23 Boom Load Charts of H Operating Condition

---

26 FJ Operating Condition of Fixed Jib

Arm Support Combination of FJ Operating Condition

---

27 Operating Range Diagram of FJ Operating Condition

---

28 Jib Load Charts of FJ Operating Condition

---

## Operating Condition Combination

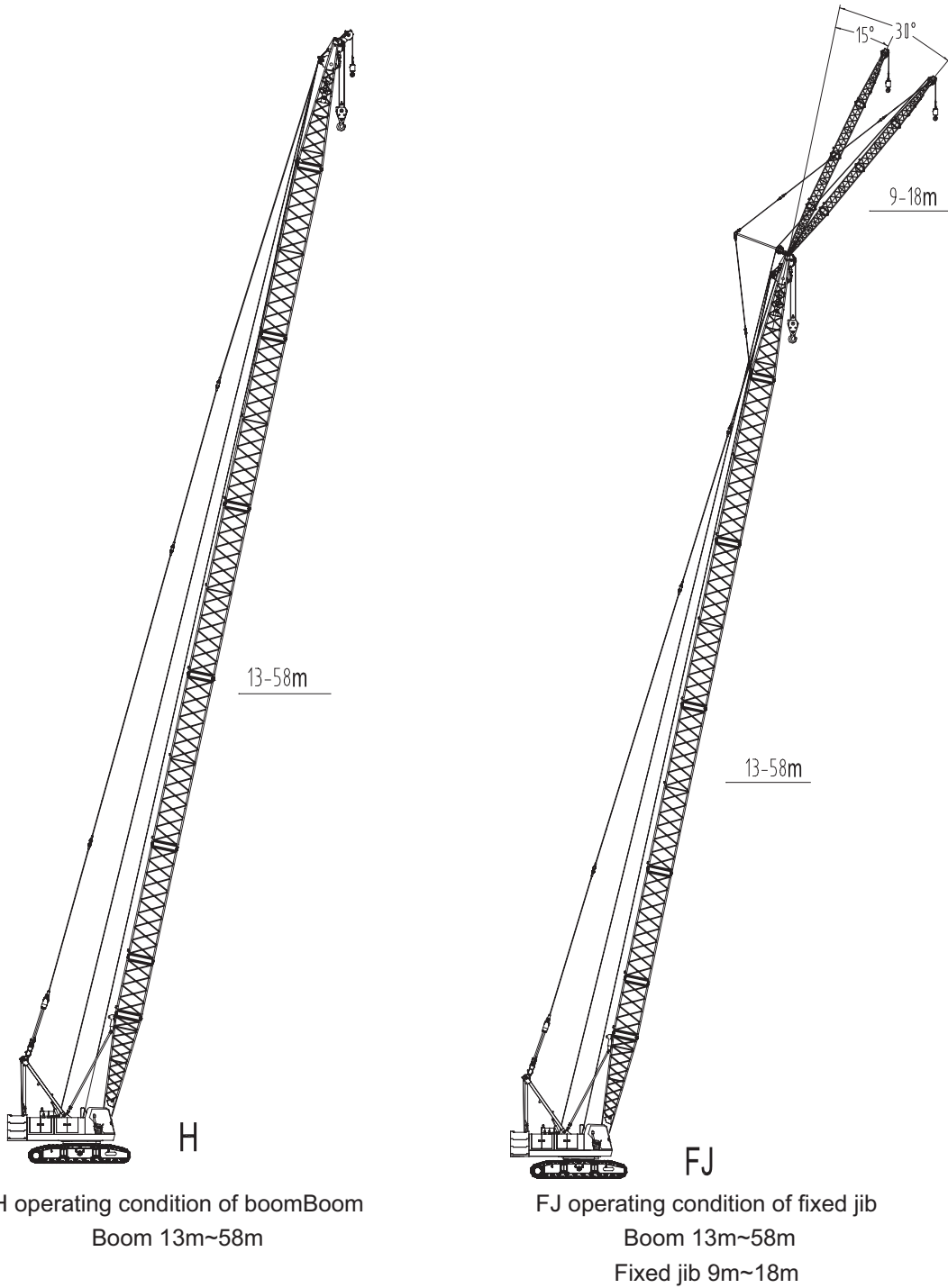

C



## H Operating Condition of Boom Boom Combination of H Operating Condition

Length of boom (m)	Insert		
	3m	6m	9m
13	-	-	-
16	1	-	-
19	-	1	-
22	-	-	1
25	1	-	1
28	-	1	1
31	1	1	1
34	1	-	2
37	-	1	2
40	1	1	2
43	-	-	3
46	-	1	3
49	1	1	3
52	-	-	4
55	-	1	4
58	1	1	4

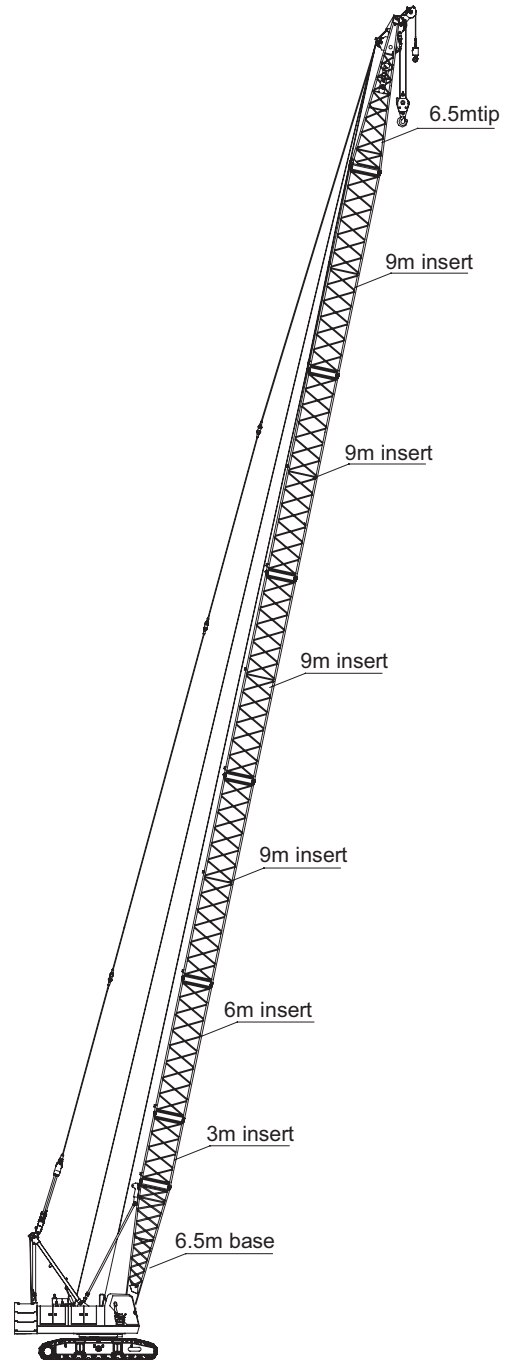



## Operating Range Diagram of H Operating Condition

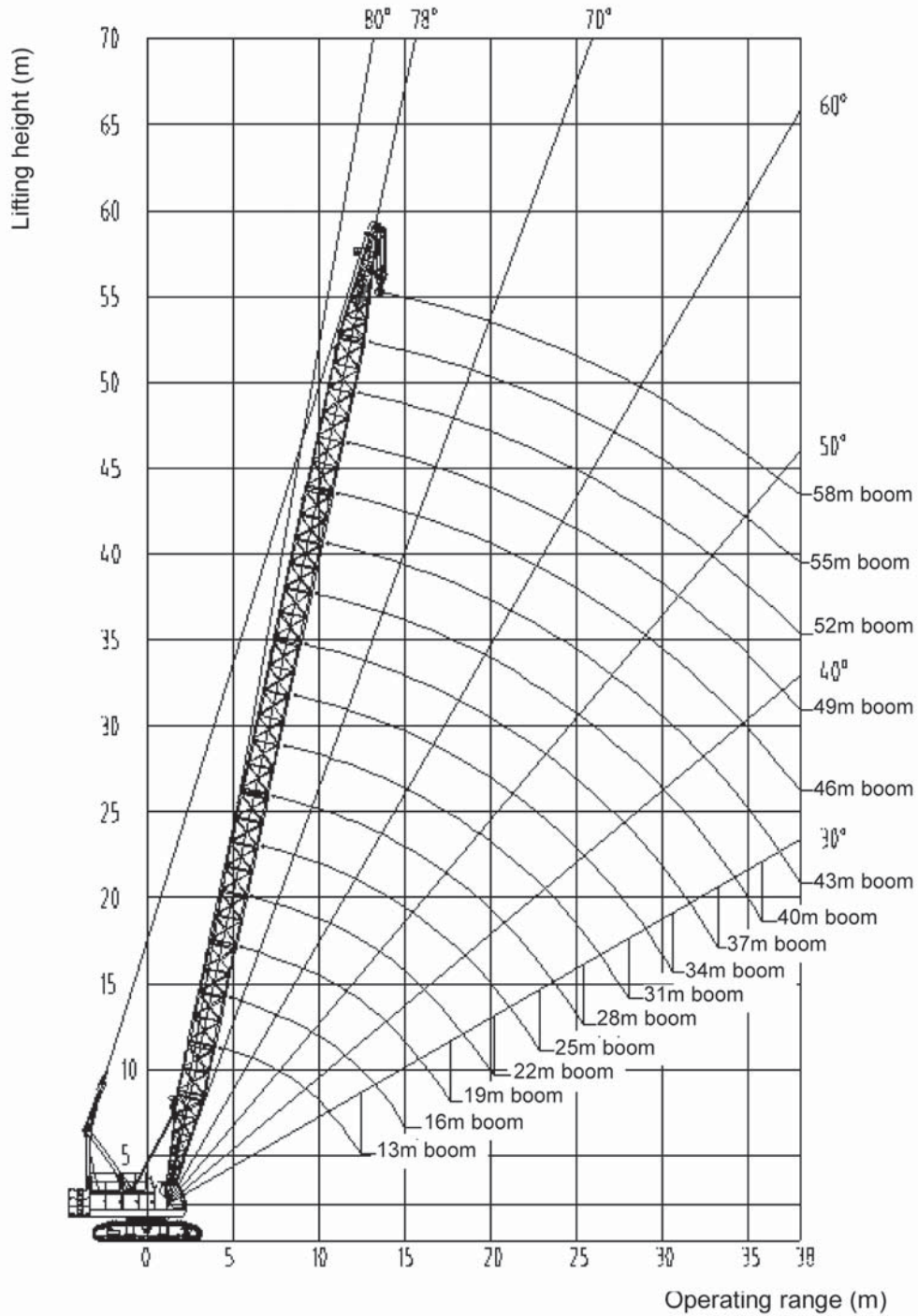



## Boom Load Charts of H Operating Condition

SCC 800C Crawler Crane – Load Chart of Boom 1/3										
Unit: t										
Radius (m)	Boom (m)									
	13	16	19	22	25	28	31		34	
4.3	80.00									
4.5	76.50									
5	68.07	66.80								
5.5	59.18	58.90	58.72							
6	52.30	52.02	51.84	51.66						
6.5	46.82	46.54	46.35	46.18	45.90					
7	42.34	42.06	41.88	41.70	41.42	40.72				
7.5	38.63	38.34	38.16	37.98	37.70	37.06	36.89	38.50		
8	35.49	35.20	35.02	34.84	34.56	33.97	33.79	35.29	33.51	35.01
8.5	32.80	32.51	32.33	32.16	31.87	31.32	31.14	32.55	30.86	32.26
9	30.47	30.19	30.01	29.83	29.55	29.02	28.85	30.17	28.56	29.88
10	26.65	26.37	26.18	26.01	25.72	25.25	25.07	26.26	24.79	25.97
11	23.64	23.35	23.17	22.99	22.71	22.28	22.10	23.17	21.81	22.88
12	21.21	20.92	20.74	20.56	20.27	19.87	19.69	20.67	19.41	20.38
13		18.91	18.73	18.55	18.27	17.88	17.71	18.60	17.42	18.32
14		17.23	17.04	16.87	16.58	16.22	16.04	16.87	15.76	16.58
15			15.61	15.43	15.15	14.80	14.62	15.39	14.34	15.11
16			14.37	14.20	13.91	13.58	13.40	14.12	13.11	13.83
18				12.18	11.89	11.58	11.40	12.04	11.12	11.75
20					10.31	10.01	9.84	10.41	9.55	10.12
22					9.03	8.75	8.58	9.09	8.29	8.81
24						7.72	7.54	8.01	7.25	7.73
26							6.67	7.11	6.36	6.82
28									5.60	6.06
30									4.94	5.39
Counterweight	27	27	27	27	27	27	27	27+2.5	27	27+2.5

## ■ Boom Load Charts of H Operating Condition

SCC 800C Crawler Crane – Load Chart of Boom 2/3										
Unit: t										
Radius (m)	Boom (m)									
	37		40		43		46		49	
8.5										
9	28.38	29.70								
10	24.60	25.78	24.43	25.61	24.14	25.32				
11	21.63	22.70	21.45	22.52	21.17	22.23	20.98	22.05		
12	19.22	20.20	19.05	20.02	18.76	19.73	18.58	19.55	18.40	19.37
13	17.24	18.13	17.06	17.95	16.77	17.67	16.59	17.48	16.41	17.30
14	15.57	16.40	15.39	16.22	15.11	15.93	14.92	15.75	14.75	15.57
15	14.15	14.92	13.98	14.74	13.69	14.46	13.50	14.27	13.33	14.09
16	12.93	13.65	12.75	13.47	12.47	13.18	12.28	13.00	12.11	12.82
18	10.93	11.57	10.75	11.39	10.47	11.10	10.28	10.92	10.11	10.74
20	9.37	9.93	9.19	9.76	8.90	9.47	8.72	9.29	8.52	9.11
22	8.11	8.62	7.93	8.44	7.61	8.16	7.41	7.97	7.22	7.79
24	7.05	7.54	6.86	7.37	6.54	7.08	6.34	6.89	6.14	6.71
26	6.15	6.64	5.96	6.46	5.64	6.17	5.44	5.96	5.25	5.77
28	5.39	5.87	5.20	5.68	4.88	5.37	4.68	5.16	4.49	4.97
30	4.74	5.19	4.55	5.00	4.23	4.68	4.03	4.48	3.83	4.28
32	4.17	4.59	3.98	4.40	3.66	4.08	3.46	3.88	3.27	3.69
34			3.48	3.88	3.17	3.56	2.97	3.36	2.77	3.16
36					2.73	3.10	2.53	2.90	2.33	2.70
38					2.34	2.69	2.14	2.49	1.94	2.29
Counterweight	27	27+2.5	27	27+2.5	27	27+2.5	27	27+2.5	27	27+2.5





## Boom Load Charts of H Operating Condition

SCC 800C Crawler Crane – Load Chart of Boom 3/3										
Unit: t										
Radius (m)	Boom (m)									
	52		55		58					
8.5										
9										
10										
11										
12	18.11	19.08								
13	16.13	17.02	15.94	16.83	15.66	16.55				
14	14.46	15.28	14.28	15.10	13.99	14.81				
15	13.04	13.81	12.86	13.62	12.57	13.34				
16	11.82	12.53	11.63	12.35	11.35	12.06				
18	9.82	10.45	9.63	10.27	9.32	9.98				
20	8.21	8.82	8.01	8.64	7.69	8.35				
22	6.90	7.51	6.70	7.32	6.39	7.01				
24	5.83	6.43	5.63	6.19	5.31	5.88				
26	4.93	5.50	4.73	5.25	4.42	4.94				
28	4.17	4.70	3.97	4.45	3.66	4.14				
30	3.52	4.01	3.32	3.77	3.00	3.45				
32	2.95	3.41	2.75	3.17	2.44	2.85				
34	2.46	2.88	2.25	2.65	1.94	2.33				
36	2.02	2.42	1.81	2.18	1.50	1.87				
38	1.63	2.01	1.42	1.77	1.11	1.46				
Counter weight	27	27+2.5	27	27+2.5	27	27+2.5	27	27+2.5	27	27+2.5



## ■ Boom Load Charts of H Operating Condition

Notes ——Rated load of crane

(1)The rated load indicated in the table is the weight hoisted slowly and stably on a level and hard soil ground when the crane does not travel.

(2)The rated load indicated in the table is the value computed by taking 75% of the tipover load.

(3)Rated load includes the weight of lifting hook, etc. The actual lifting capacity is the value obtained by deducting the weight of hoisting tools (e.g. lifting hook) (the weight of 80t lifting hook is 1.35t, that of 50t lifting hook 0.97t, that of 25t lifting hook 0.55t, and that of 9t hook block 0.35t from the rated load in the table.

(4)Upon assembly of jib or extension arm, the rated load includes the weight of main and auxiliary lifting hooks and values listed in the table below. The actual lifting capacity of crane is the value in the load chart of boom minus the weights listed in the table below and equivalent weights of main hook, auxiliary hook, wire rope, hoisting tools, etc., converted into the boom head, but the crane cannot work when the remained value is below 0.8t.

(5)The boom to which a jib can be mounted is 37m~52m long.

(6)When the crane is hoisting load, the crawler frame must be in the state of extension.

(7)The relationship between the multiplying factor of wire rope and max. rated load as well as weight of hook is shown as below.

(8) All values in the load chart are suitable for 360o slewing.

Specification of lifting hook	Weight of lifting hook (t)	Max. rated load (t)					
		12Multiplying factor	11Multiplying factor	10Multiplying factor	9Multiplying factor	8Multiplying factor	7Multiplying factor
80t	1.35	80	73.3	66.7	60	53.3	46.7
50t	0.97						47.2
25t	0.55						
9t	0.35						

Specification of lifting hook	Weight of lifting hook (t)	Max. rated load (t)					
		6Multiplying factor	5Multiplying factor	4Multiplying factor	3Multiplying factor	2Multiplying factor	1Multiplying factor
80t	1.35	40	33.3	26.7	20	13.3	6.7
50t	0.97	40.5	33.8	27.2	20.5	13.8	7.2
25t	0.55						7.4

(9)When additional counterweight (27t+2.5t) is used, it is an optional operating condition, rather than a standard operating condition. The boom allowing to use additional counterweight is 31m~58m long.



FJ Operating Condition of Fixed Jib  
Arm Support Combination of FJ Operating Condition

## FJ Operating Condition of Fixed Jib Arm Support Combination of FJ Operating Condition

Length of jib (m)	Insert
9	-
13.5	1
18	2

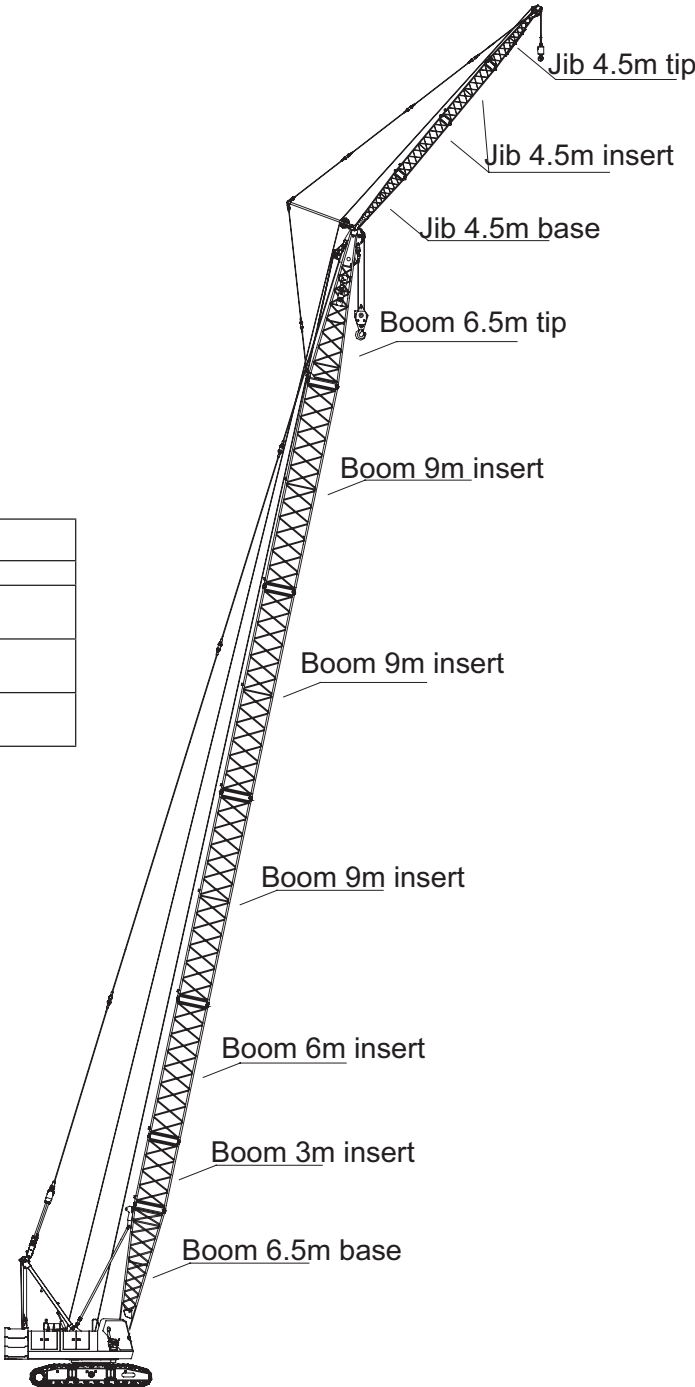

**Operating Range Diagram of FJ Operating Condition**

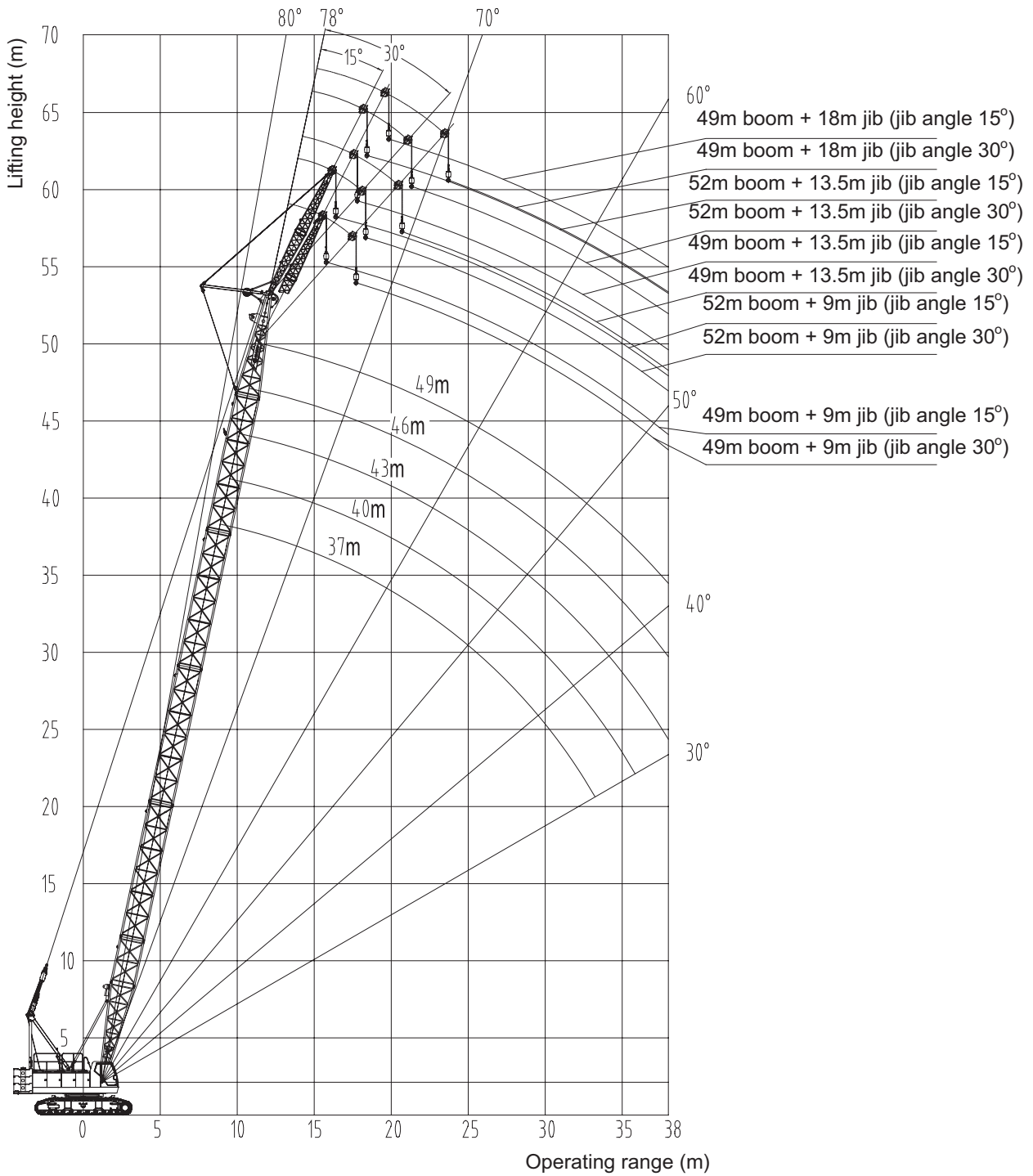



Jib Load Charts of FJ Operating Condition

# Jib Load Charts of FJ Operating Condition

SCC 800C Crawler Crane – Load Chart of Fixed Jib 1/3												
Unit: t												
Boom length (m)	37m											
Jib length (m)	9m				13.5m				18m			
Jib angle	15°		30°		15°		30°		15°		30°	
Boom angle												
58°	4.78	5.16	4.51	4.87	4.06	4.40	3.60	3.60	3.48	3.50	2.40	2.40
59°	5.00	5.39	4.71	5.00	4.25	4.60	3.60	3.60	3.50	3.50	2.40	2.40
60°	5.24	5.64	4.91	5.00	4.46	4.82	3.60	3.60	3.50	3.50	2.40	2.40
61°	5.49	5.90	5.00	5.00	4.67	5.04	3.60	3.60	3.50	3.50	2.40	2.40
62°	5.76	6.00	5.00	5.00	4.90	5.27	3.60	3.60	3.50	3.50	2.40	2.40
63°	6.00	6.00	5.00	5.00	5.15	5.53	3.60	3.60	3.50	3.50	2.40	2.40
64°	6.00	6.00	5.00	5.00	5.41	5.81	3.60	3.60	3.50	3.50	2.40	2.40
65°	6.00	6.00	5.00	5.00	5.70	6.00	3.60	3.60	3.50	3.50	2.40	2.40
66°	6.00	6.00	5.00	5.00	6.00	6.00	3.60	3.60	3.50	3.50	2.40	2.40
67°	6.00	6.00	5.00	5.00	6.00	6.00	3.60	3.60	3.50	3.50	2.40	2.40
68°	6.00	6.00	5.00	5.00	6.00	6.00	3.60	3.60	3.50	3.50	2.40	2.40
69°	6.00	6.00	5.00	5.00	6.00	6.00	3.60	3.60	3.50	3.50	2.40	2.40
70°	6.00	6.00	5.00	5.00	6.00	6.00	3.60	3.60	3.50	3.50	2.40	2.40
71°	6.00	6.00	5.00	5.00	6.00	6.00	3.60	3.60	3.50	3.50	2.40	2.40
72°	6.00	6.00	5.00	5.00	6.00	6.00	3.60	3.60	3.50	3.50	2.40	2.40
73°	6.00	6.00	5.00	5.00	6.00	6.00	3.60	3.60	3.50	3.50	2.40	2.40
74°	6.00	6.00	5.00	5.00	6.00	6.00	3.60	3.60	3.50	3.50	2.40	2.40
75°	6.00	6.00	5.00	5.00	6.00	6.00	3.60	3.60	3.50	3.50	2.40	2.40
76°	6.00	6.00	5.00	5.00	6.00	6.00	3.60	3.60	3.50	3.50	2.40	2.40
77°	6.00	6.00	5.00	5.00	6.00	6.00	3.60	3.60	3.50	3.50	2.40	2.40
78°	6.00	6.00	5.00	5.00	6.00	6.00	3.60	3.60	3.50	3.50	2.40	2.40
Counterweight	27	27+2.5	27	27+2.5	27	27+2.5	27	27+2.5	27	27+2.5	27	27+2.5
Boom length (m)	40m											
Jib length (m)	9m				13.5m				18m			
Jib angle	15°		30°		15°		30°		15°		30°	
Boom angle												
58°	4.13	4.49	3.91	4.25	3.52	3.84	3.26	3.56	3.01	3.30	2.40	2.40
59°	4.34	4.71	4.10	4.45	3.70	4.03	3.41	3.60	3.17	3.47	2.40	2.40
60°	4.57	4.95	4.30	4.66	3.89	4.23	3.50	3.60	3.34	3.50	2.40	2.40
61°	4.81	5.20	4.51	4.88	4.10	4.45	3.60	3.60	3.50	3.50	2.40	2.40
62°	5.06	5.46	4.74	5.00	4.32	4.68	3.60	3.60	3.50	3.50	2.40	2.40
63°	5.34	5.75	4.98	5.00	4.56	4.93	3.60	3.60	3.50	3.50	2.40	2.40
64°	5.63	6.00	5.00	5.00	4.71	5.09	3.60	3.60	3.50	3.50	2.40	2.40
65°	5.95	6.00	5.00	5.00	5.09	5.48	3.60	3.60	3.50	3.50	2.40	2.40
66°	6.00	6.00	5.00	5.00	5.38	5.78	3.60	3.60	3.50	3.50	2.40	2.40
67°	6.00	6.00	5.00	5.00	5.70	6.00	3.60	3.60	3.50	3.50	2.40	2.40
68°	6.00	6.00	5.00	5.00	6.00	6.00	3.60	3.60	3.50	3.50	2.40	2.40
69°	6.00	6.00	5.00	5.00	6.00	6.00	3.60	3.60	3.50	3.50	2.40	2.40
70°	6.00	6.00	5.00	5.00	6.00	6.00	3.60	3.60	3.50	3.50	2.40	2.40
71°	6.00	6.00	5.00	5.00	6.00	6.00	3.60	3.60	3.50	3.50	2.40	2.40
72°	6.00	6.00	5.00	5.00	6.00	6.00	3.60	3.60	3.50	3.50	2.40	2.40
73°	6.00	6.00	5.00	5.00	6.00	6.00	3.60	3.60	3.50	3.50	2.40	2.40
74°	6.00	6.00	5.00	5.00	6.00	6.00	3.60	3.60	3.50	3.50	2.40	2.40
75°	6.00	6.00	5.00	5.00	6.00	6.00	3.60	3.60	3.50	3.50	2.40	2.40
76°	6.00	6.00	5.00	5.00	6.00	6.00	3.60	3.60	3.50	3.50	2.40	2.40
77°	6.00	6.00	5.00	5.00	6.00	6.00	3.60	3.60	3.50	3.50	2.40	2.40
78°	6.00	6.00	5.00	5.00	6.00	6.00	3.60	3.60	3.50	3.50	2.40	2.40
Counterweight	27	27+2.5	27	27+2.5	27	27+2.5	27	27+2.5	27	27+2.5	27	27+2.5

Note: The 40% grey and italic parts in the table indicate the rated loads with additional counterweight, the values in the 25% grey parts with frame depend on the strength of arm support.

## Jib Load Charts of FJ Operating Condition

SCC 800C Crawler Crane – Load Chart of Fixed Jib 2/3												
Unit: t												
Boom length (m)	43m											
Jib length (m)	9m				13.5m				18m			
Jib angle	15°		30°		15°		30°		15°		30°	
Boom angle												
58°	3.59	3.93	3.40	3.73	3.05	3.36	2.83	3.12	2.60	2.88	2.37	2.40
59°	3.78	4.13	3.58	3.91	3.22	3.54	2.98	3.28	2.76	3.05	2.40	2.40
60°	4.00	4.36	3.77	4.11	3.41	3.73	3.14	3.44	2.92	3.21	2.40	2.40
61°	4.22	4.59	3.97	4.32	3.61	3.94	3.32	3.60	3.18	3.48	2.40	2.40
62°	4.47	4.85	4.19	4.55	3.82	4.16	3.50	3.60	3.29	3.50	2.40	2.40
63°	4.73	5.12	4.42	4.79	4.05	4.40	3.60	3.60	3.49	3.50	2.40	2.40
64°	5.01	5.41	4.64	5.00	4.29	4.65	3.60	3.60	3.50	3.50	2.40	2.40
65°	5.31	5.72	4.94	5.00	4.55	4.92	3.60	3.60	3.50	3.50	2.40	2.40
66°	5.64	6.00	5.00	5.00	4.84	5.22	3.60	3.60	3.50	3.50	2.40	2.40
67°	6.00	6.00	5.00	5.00	5.14	5.54	3.60	3.60	3.50	3.50	2.40	2.40
68°	6.00	6.00	5.00	5.00	5.47	5.88	3.60	3.60	3.50	3.50	2.40	2.40
69°	6.00	6.00	5.00	5.00	5.83	6.00	3.60	3.60	3.50	3.50	2.40	2.40
70°	6.00	6.00	5.00	5.00	6.00	6.00	3.60	3.60	3.50	3.50	2.40	2.40
71°	6.00	6.00	5.00	5.00	6.00	6.00	3.60	3.60	3.50	3.50	2.40	2.40
72°	6.00	6.00	5.00	5.00	6.00	6.00	3.60	3.60	3.50	3.50	2.40	2.40
73°	6.00	6.00	5.00	5.00	6.00	6.00	3.60	3.60	3.50	3.50	2.40	2.40
74°	6.00	6.00	5.00	5.00	6.00	6.00	3.60	3.60	3.50	3.50	2.40	2.40
75°	6.00	6.00	5.00	5.00	6.00	6.00	3.60	3.60	3.50	3.50	2.40	2.40
76°	6.00	6.00	5.00	5.00	6.00	6.00	3.60	3.60	3.50	3.50	2.40	2.40
77°	6.00	6.00	5.00	5.00	6.00	6.00	3.60	3.60	3.50	3.50	2.40	2.40
78°	6.00	6.00	5.00	5.00	6.00	6.00	3.60	3.60	3.50	3.50	2.40	2.40
Counterweight	27	27+2.5	27	27+2.5	27	27+2.5	27	27+2.5	27	27+2.5	27	27+2.5
Boom length (m)	46m											
Jib length (m)	9m				13.5m				18m			
Jib angle	15°		30°		15°		30°		15°		30°	
Boom angle												
58°	3.04	3.36	2.88	3.19	2.58	2.87	2.39	2.67	2.19	2.46	1.99	2.24
59°	3.23	3.56	3.06	3.38	2.74	3.04	2.54	2.82	2.34	2.62	2.12	2.38
60°	3.43	3.77	3.24	3.57	2.92	3.23	2.70	2.99	2.50	2.78	2.26	2.40
61°	3.65	4.00	3.44	3.77	3.11	3.43	2.87	3.17	2.67	2.96	2.38	2.40
62°	3.88	4.24	3.65	3.99	3.32	3.65	3.04	3.34	2.85	3.15	2.40	2.40
63°	4.13	4.50	3.87	4.22	3.53	3.86	3.23	3.54	3.04	3.35	2.40	2.40
64°	4.39	4.77	4.11	4.47	3.77	4.11	3.43	3.60	3.25	3.50	2.40	2.40
65°	4.68	5.07	4.36	4.73	4.02	4.38	3.60	3.60	3.47	3.50	2.40	2.40
66°	5.00	5.41	4.64	5.00	4.29	4.66	3.60	3.60	3.50	3.50	2.40	2.40
67°	5.34	5.76	4.94	5.00	4.59	4.97	3.60	3.60	3.50	3.50	2.40	2.40
68°	5.70	6.00	5.00	5.00	4.91	5.30	3.60	3.60	3.50	3.50	2.40	2.40
69°	6.00	6.00	5.00	5.00	5.25	5.66	3.60	3.60	3.50	3.50	2.40	2.40
70°	6.00	6.00	5.00	5.00	5.63	6.00	3.60	3.60	3.50	3.50	2.40	2.40
71°	6.00	6.00	5.00	5.00	6.00	6.00	3.60	3.60	3.50	3.50	2.40	2.40
72°	6.00	6.00	5.00	5.00	6.00	6.00	3.60	3.60	3.50	3.50	2.40	2.40
73°	6.00	6.00	5.00	5.00	6.00	6.00	3.60	3.60	3.50	3.50	2.40	2.40
74°	6.00	6.00	5.00	5.00	6.00	6.00	3.60	3.60	3.50	3.50	2.40	2.40
75°	6.00	6.00	5.00	5.00	6.00	6.00	3.60	3.60	3.50	3.50	2.40	2.40
76°	6.00	6.00	5.00	5.00	6.00	6.00	3.60	3.60	3.50	3.50	2.40	2.40
77°	6.00	6.00	5.00	5.00	6.00	6.00	3.60	3.60	3.50	3.50	2.40	2.40
78°	6.00	6.00	5.00	5.00	6.00	6.00	3.60	3.60	3.50	3.50	2.40	2.40
Counterweight	27	27+2.5	27	27+2.5	27	27+2.5	27	27+2.5	27	27+2.5	27	27+2.5

Note: The 40% grey and italic parts in the table indicate the rated loads with additional counterweight, the values in the 25% grey parts with frame depend on the strength of arm support.



Jib Load Charts of FJ Operating Condition

# Jib Load Charts of FJ Operating Condition

SCC 800C Crawler Crane – Load Chart of Fixed Jib 3/3												
Unit: t												
Boom length (m)	49m											
Jib length (m)	9m				13.5m				18m			
Jib angle / Boom angle	15°		30°		15°		30°		15°		30°	
58°	2.56	2.87	2.43	2.73	2.18	2.46	2.02	2.29	1.83	2.09	1.67	1.91
59°	2.74	3.06	2.60	2.90	2.34	2.63	2.17	2.44	1.98	2.24	1.79	2.04
60°	2.93	3.25	2.78	3.09	2.51	2.81	2.32	2.60	2.13	2.40	1.93	2.18
61°	3.14	3.47	2.96	3.28	2.69	2.99	2.48	2.77	2.29	2.57	2.07	2.33
62°	3.36	3.70	3.17	3.50	2.80	3.11	2.65	2.94	2.47	2.76	2.22	2.40
63°	3.60	3.95	3.30	3.64	3.09	3.41	2.84	3.14	2.66	2.95	2.38	2.40
64°	3.85	4.21	3.61	3.96	3.32	3.65	3.03	3.34	2.86	3.16	2.40	2.40
65°	4.13	4.51	3.86	4.22	3.56	3.90	3.24	3.56	3.07	3.38	2.40	2.40
66°	4.43	4.82	4.12	4.49	3.72	4.07	3.47	3.60	3.31	3.50	2.40	2.40
67°	4.75	5.15	4.41	4.79	4.11	4.47	3.60	3.60	3.50	3.50	2.40	2.40
68°	5.11	5.53	4.72	5.00	4.41	4.79	3.60	3.60	3.50	3.50	2.40	2.40
69°	5.49	5.92	5.00	5.00	4.75	5.14	3.60	3.60	3.50	3.50	2.40	2.40
70°	5.91	6.00	5.00	5.00	5.11	5.51	3.60	3.60	3.50	3.50	2.40	2.40
71°	6.00	6.00	5.00	5.00	5.52	5.94	3.60	3.60	3.50	3.50	2.40	2.40
72°	6.00	6.00	5.00	5.00	5.96	6.00	3.60	3.60	3.50	3.50	2.40	2.40
73°	6.00	6.00	5.00	5.00	6.00	6.00	3.60	3.60	3.50	3.50	2.40	2.40
74°	6.00	6.00	5.00	5.00	6.00	6.00	3.60	3.60	3.50	3.50	2.40	2.40
75°	6.00	6.00	5.00	5.00	6.00	6.00	3.60	3.60	3.50	3.50	2.40	2.40
76°	6.00	6.00	5.00	5.00	6.00	6.00	3.60	3.60	3.50	3.50	2.40	2.40
77°	6.00	6.00	5.00	5.00	6.00	6.00	3.60	3.60	3.50	3.50	2.40	2.40
78°	6.00	6.00	5.00	5.00	6.00	6.00	3.60	3.60	3.50	3.50	2.40	2.40
Counterweight	27	27+2.5	27	27+2.5	27	27+2.5	27	27+2.5	27	27+2.5	27	27+2.5
Boom length (m)	52m											
Jib length (m)	9m				13.5m							
Jib angle / Boom angle	15°		30°		15°		30°					
58°	2.05	2.35	1.94	2.22	1.74	2.01	1.62	1.88				
59°	2.19	2.49	2.08	2.37	1.90	2.18	1.76	2.02				
60°	2.34	2.65	2.22	2.52	2.06	2.34	1.91	2.18				
61°	2.51	2.83	2.37	2.68	2.24	2.53	2.06	2.33				
62°	2.69	3.02	2.54	2.85	2.42	2.72	2.23	2.51				
63°	2.88	3.22	2.64	2.96	2.63	2.94	2.41	2.70				
64°	3.08	3.43	2.89	3.22	2.84	3.16	2.60	2.90				
65°	3.30	3.66	3.09	3.43	3.08	3.41	2.88	3.18				
66°	3.54	3.91	3.30	3.65	3.33	3.67	3.02	3.33				
67°	3.80	4.18	3.53	3.89	3.60	3.95	3.26	3.58				
68°	4.09	4.49	3.78	4.00	3.90	4.26	3.51	3.60				
69°	4.39	4.80	4.00	4.00	4.22	4.59	3.60	3.60				
70°	4.73	4.80	4.00	4.00	4.50	4.80	3.60	3.60				
71°	4.80	4.80	4.00	4.00	4.66	4.80	3.60	3.60				
72°	4.80	4.80	4.00	4.00	4.80	4.80	3.60	3.60				
73°	4.80	4.80	4.00	4.00	4.80	4.80	3.60	3.60				
74°	4.80	4.80	4.00	4.00	4.80	4.80	3.60	3.60				
75°	4.80	4.80	4.00	4.00	4.80	4.80	3.60	3.60				
76°	4.80	4.80	4.00	4.00	4.80	4.80	3.60	3.60				
77°	4.80	4.80	4.00	4.00	4.80	4.80	3.60	3.60				
78°	4.80	4.80	4.00	4.00	4.80	4.80	3.60	3.60				
Counterweight	27	27+2.5	27	27+2.5	27	27+2.5	27	27+2.5				

Note: The 40% grey and italic parts in the table indicate the rated loads with additional counterweight, the values in the 25% grey parts with frame depend on the strength of arm support.



**Shanghai Sany Science&Technology Co.,Ltd.**

No.319, Chuanda Rd, Chuansha Economic Park, Pudong District, Shanghai 201200.P.R.China

Tel:0086-021-58595081(Sales) 0086-021-58593139(Service)

Fax:0086-021-58595081

Website: [www.sanygroup.com](http://www.sanygroup.com)

Materials and specifications are subject to change without further notice in accordance with constant technical innovations.  
Photos may include additional equipment.

Copyright ©2010 SANY Group Co.,Ltd. All rights reserved.